

# Chapter 11 :

## Other Applications of HSAB Principle

# ***11. Other Application of the HSAB principle***

***11.1. Solubility and protonation***

***11.2. Carbenes and nitrenes***

***11.3. Organic chemistry of group IV elements***

***11.4. Reactions of organohalides grignard and  
related reagents***

***11.5. Exceptions***

## ***Other Applications of the HSAB Principle***

**A number of HSAB-pertinent organochemical subjects which have not been discussed in the previous chapters will now be considered. Again the selection of topics is arbitrary, illustrative rather than comprehensive. Some notable exceptions to the HSAB principle are also presented.**

## *Solubility and Protonation*

**Water is a typical hard solvent which solubilizes hard acid, hard bases and hard complexes. The electromotive series indicates that Pt, Hg, Au, Cu, Ag and the like are unreactive and all these metals form soft ions. Their softness has a direct bearing on their low reactivity in an aqueous environment.**

**A series of well-defined macrocyclic polyethers (crown ethers) have been synthesized by Pedersen, who also demonstrated the capability of complexing and lipophilizing alkali metal ions. The  $\text{KMnO}_4$ -18-crown-6 complex is soluble in benzene. Potassium metal is solubilized by a dinaphthalenated cyclic polyether to form the interesting  $\text{K}^+$ -encapsulated anion radical.**

**Guanidinium ion acts as a guest in the ethereal cavity during cyclization of compound 3. hydrogen bondings.**

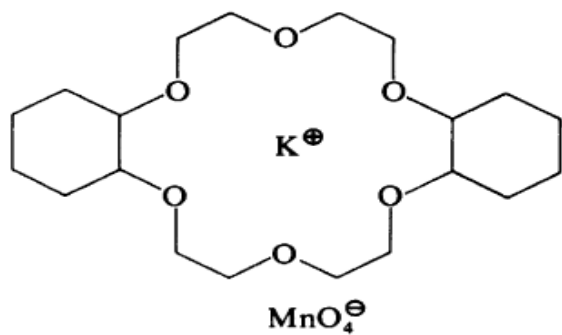

(1)

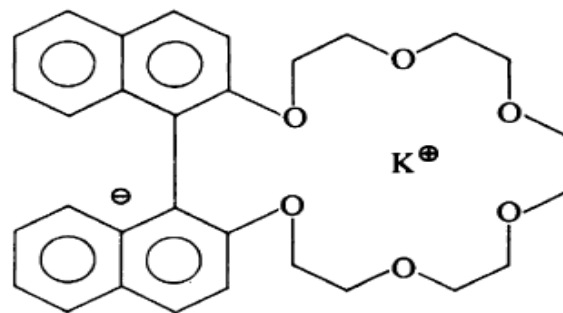

(2)

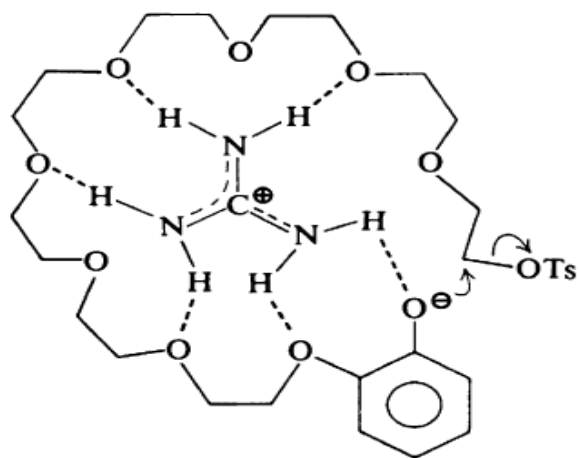

(3)

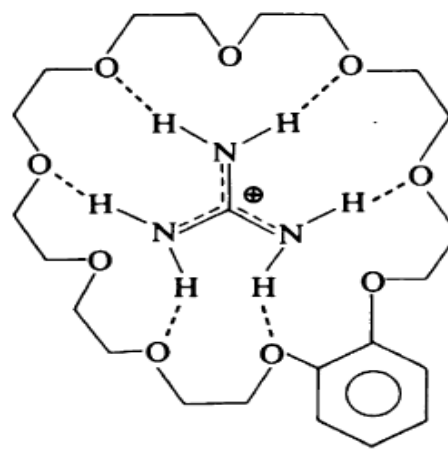
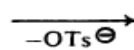

All the poly ethers provide specific residence sites for hard metal ions of appropriate radii; cyclic polysulfides of similar structures prefer complexing soft heavy metal ions.

Neutralization of enolates such as that of acetoacetic ester gives the enols instead of the thermodynamically more stable ketones directly. Protonation at the hard basic site agrees with the HSAB principle. Initial protonation of ions occurs at oxygen also.

nonconjugated diene is produced on protonation of pentadienyl anion. The central carbon atom is harder.

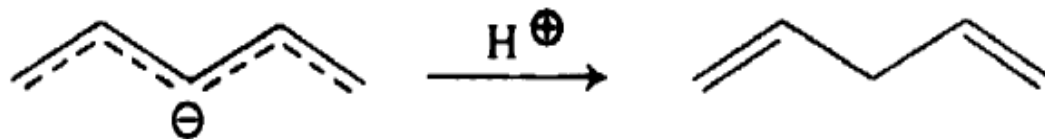

**Metallocenes can be protonated at the metal site by strong acids. The M-H<sup>+</sup> bond formation is more facile when the metal is harder, e.g., Fe > Ru > Os.**

**Acylferrocenes undergo protonation only at the carbonyl oxygen under stable ion conditions. The oxygen atom in these molecules is by far the harder base compared to iron.**



## *Carbenes and nitrenes*

**Thermolysis of phenyl trihalomethylmercurys gives dihalocarbenes. This reaction works well when one of the halogens is bromine, or better, iodine.**

**For the iodo derivatives, decomposition occurs at room temperature. The decomposition of phenyl trichloromethylmercury is best accomplished by the addition of iodide ion which has a high affinity for mercury ion because both are soft.**

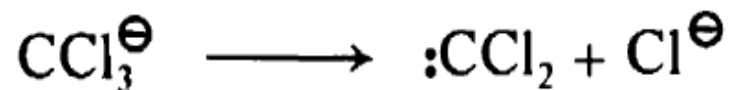
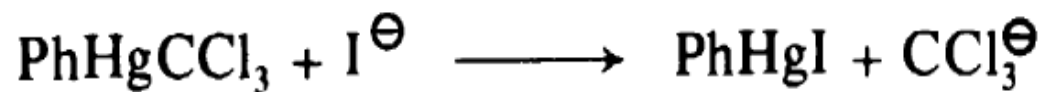
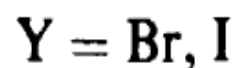
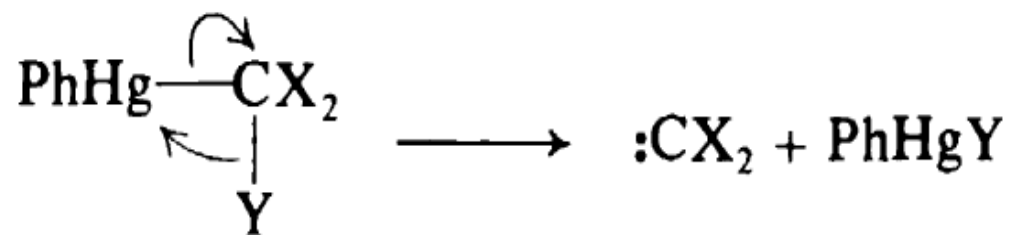

An allylic halogen atom is capable of directing the attack of carbenes (carbenoids) by acting as a temporary trap for these species. Bromine is more efficient than chlorine, as expected.

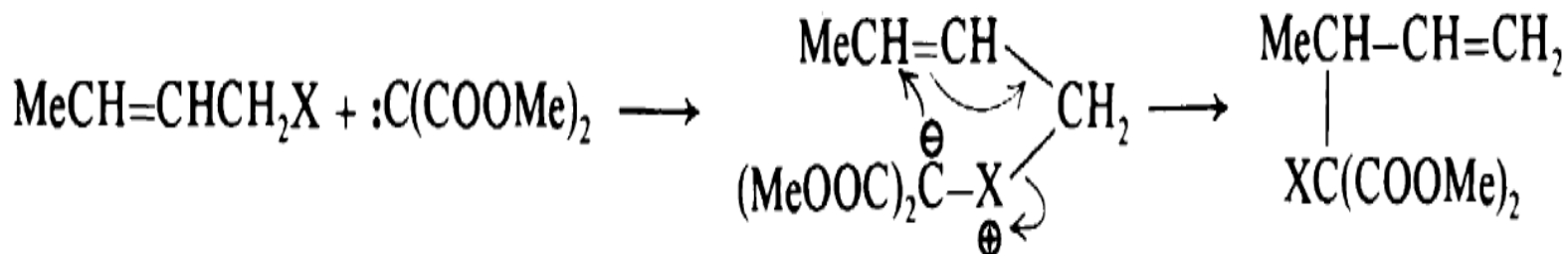

**Although allyl ethers have a hard oxygen atom they do not react in the same way. It should be noted that complexation of such oxygen with the harder bis-(methoxycarbonyl)carbenoid is more facile than with methylenoid.**

**Reimer-Tiemann reaction probably involves the attack of dichlorocarbene at the carbon of the ambident phenoxide ion. Conversely, only the oxy site of phenoxide ion intercepts the much harder difluorocarbene.**

**Dibromocarbene attacks on the soft donor atom of thiophenoxide to give triphenylthiomethane via further S<sub>N</sub>2 displacement of the intermediate.**



**Although the trapping of carbenes by hard bases is unfavorable, as further substantiated by the nontransient survival of dihalocarbenes in strong alkaline media, circumstances may indicate such a route as the only available pathway. Thus, azodiformate esters react with dichlorocarbene via their nitrogen atom**

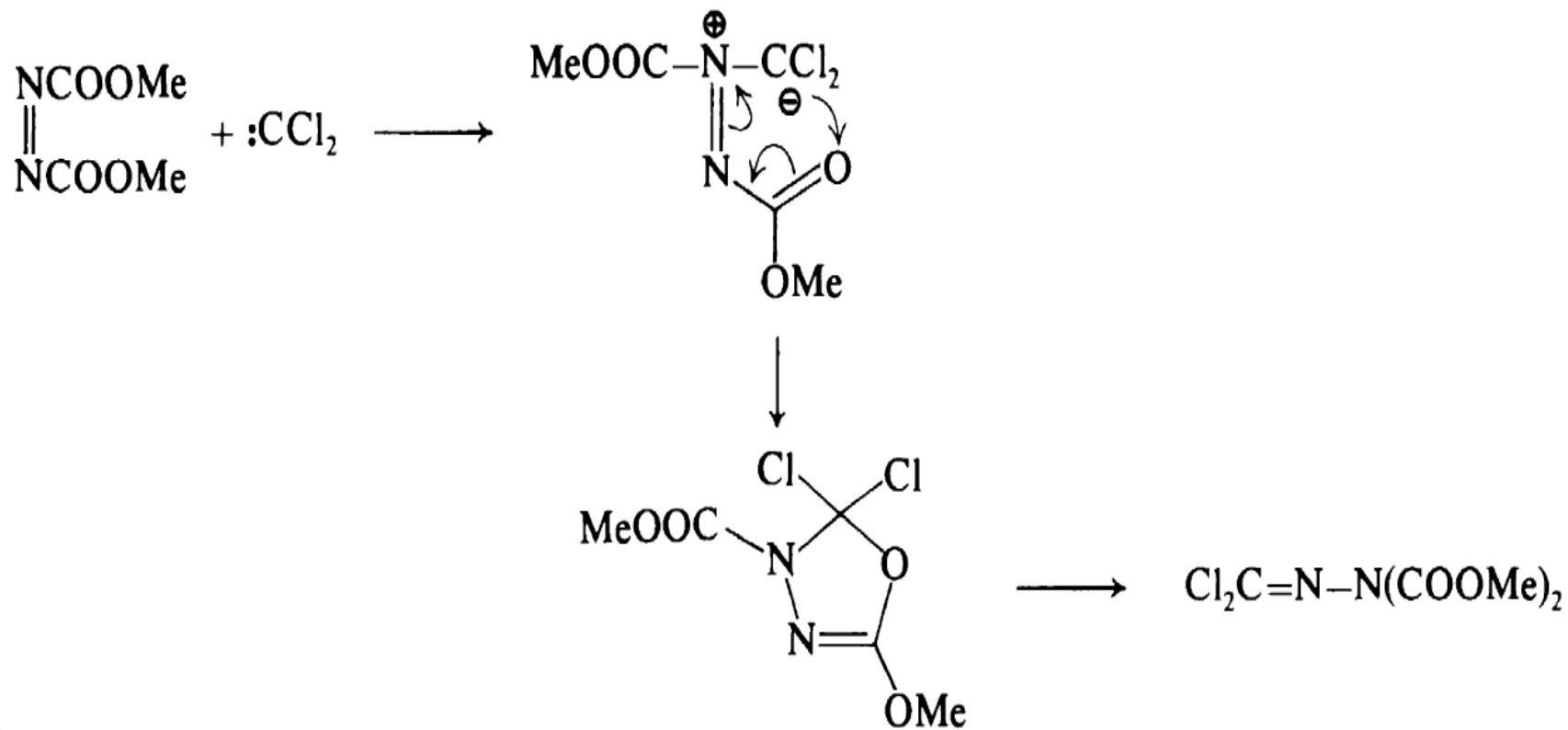

**Diazo compounds having a  $\beta$  heterosubstituent decompose via carbenic rearrangement to afford olefinic products. Only hydrogen shift occurs in cases where the substituents are OR or NMe<sub>2</sub>. Thioether rearrangement predominates when the  $\beta$  group is SR.**

**The implication from these different results is clear. Whereas hard basic functions do not interact with the neighboring carbenic center, specific soft interactions are responsible for the shift of the sulfur substituent.**



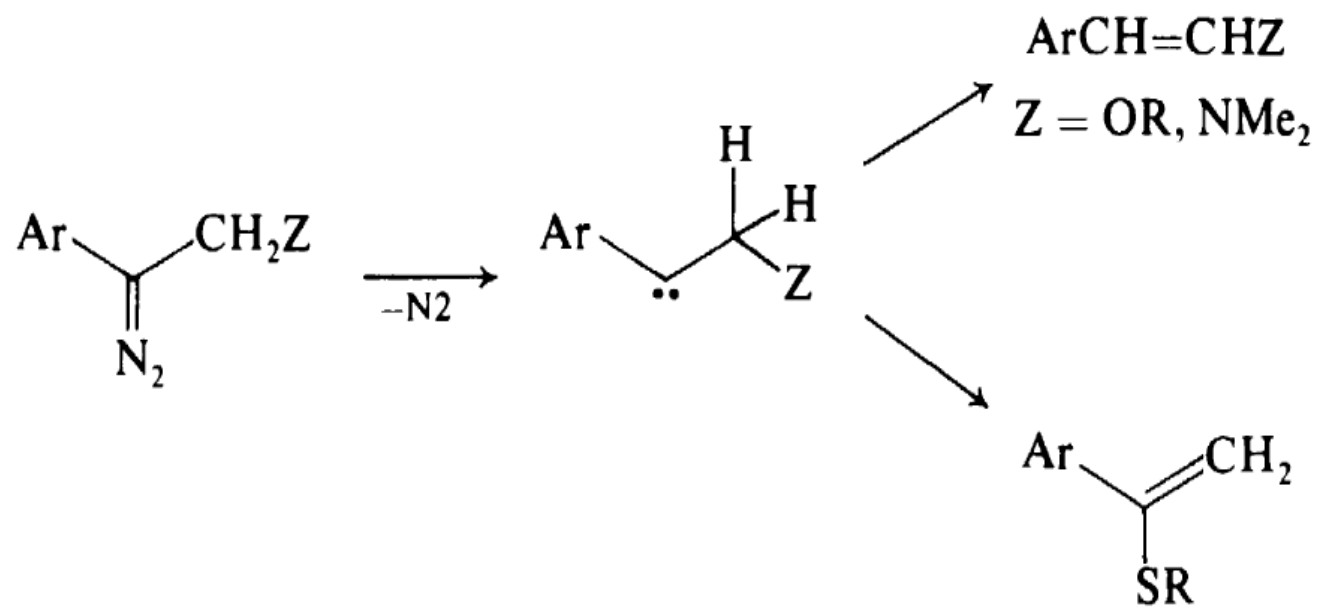

**Styrylidine generated by thermolysis of the benzylidene derivative of Meldrum's acid undergoes internal hydride migration three times as fast as the phenyl shift.**

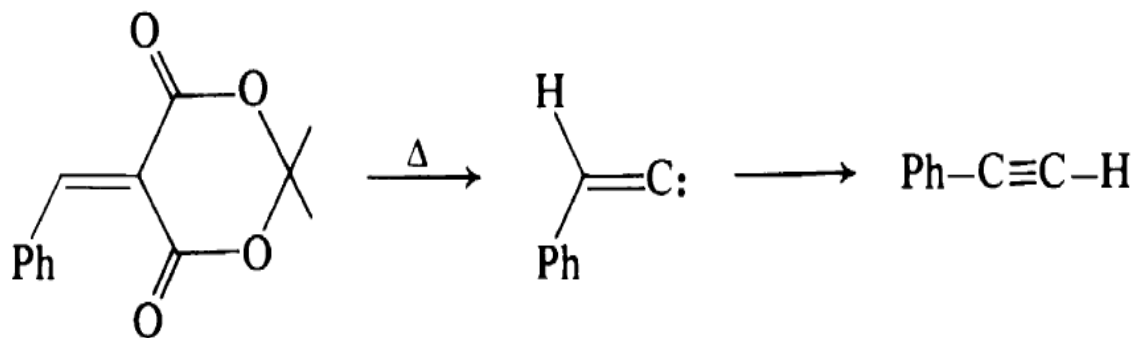

**1 -Trimethylsilyl-1 -trimethylsiloxy-2-methylpropene undergoes thermal decomposition to the unsaturated carbene and hexamethyldisiloxane. The driving force for this reaction is the favorable Si-O bond formation between the hard acid and base moieties.**

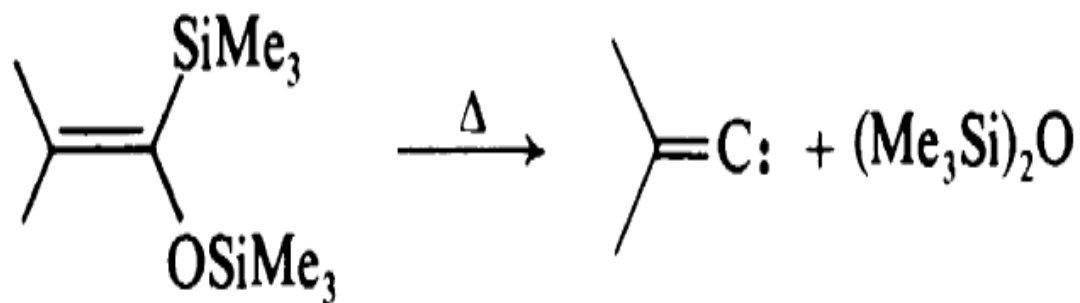

Metal-carbene complexes react with Wittig reagents to give olefins. The initial C—C bond formation is a soft-soft interaction; subsequent decomposition of the intermediates is also highly favored as the metal complexes generated are symbiotically stabilized.

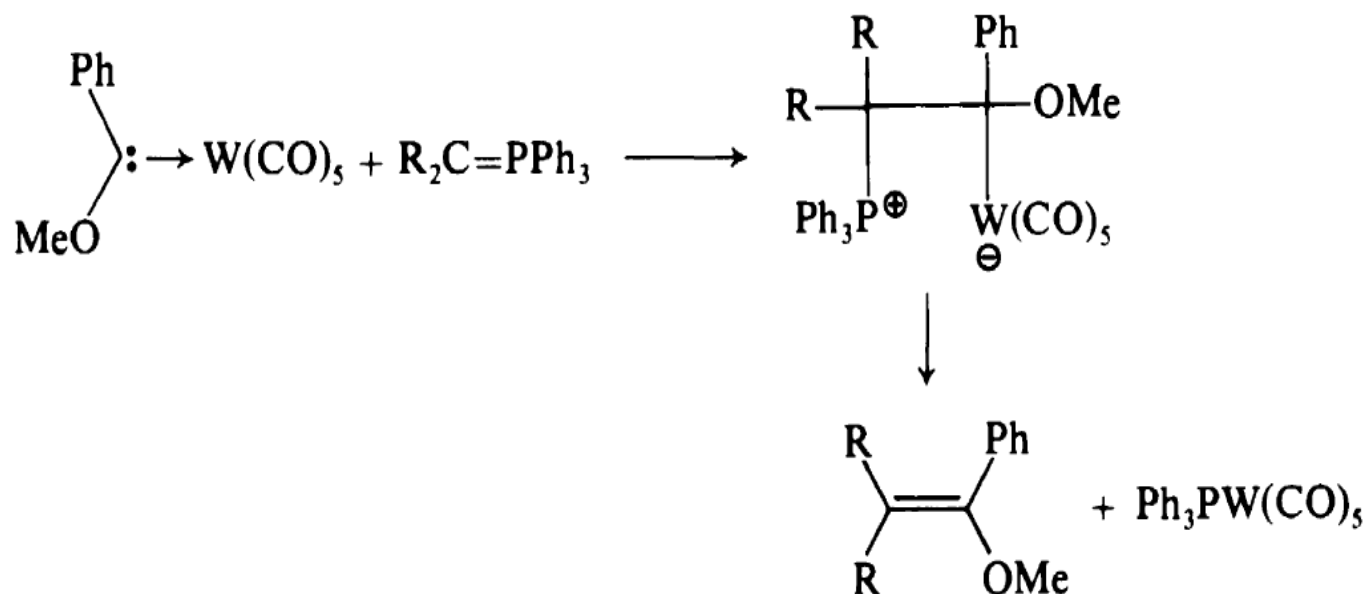



**Isonitriles are generally considered hybrids having the canonical structures.**

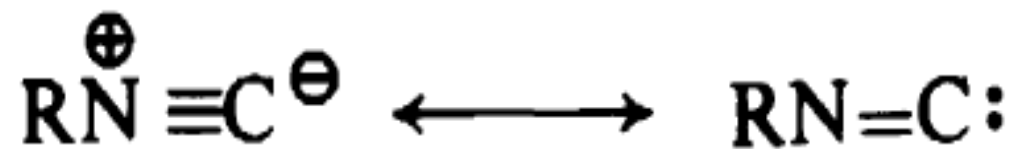

**They exhibit typical soft characteristics in reactions with Michael acceptors, positive halogen compounds, and elemental sulfur. They intercept carbenes, nitrenes, and benzyne to give  $\alpha$ -addition products.**

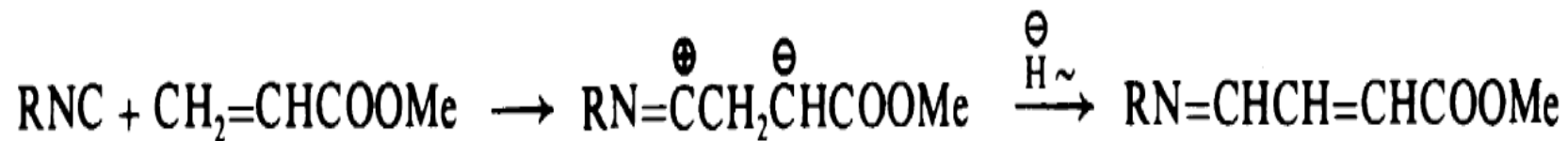

**Cycloaddition of isonitrile to cycloalkynes is also typical of carbene reactions.**

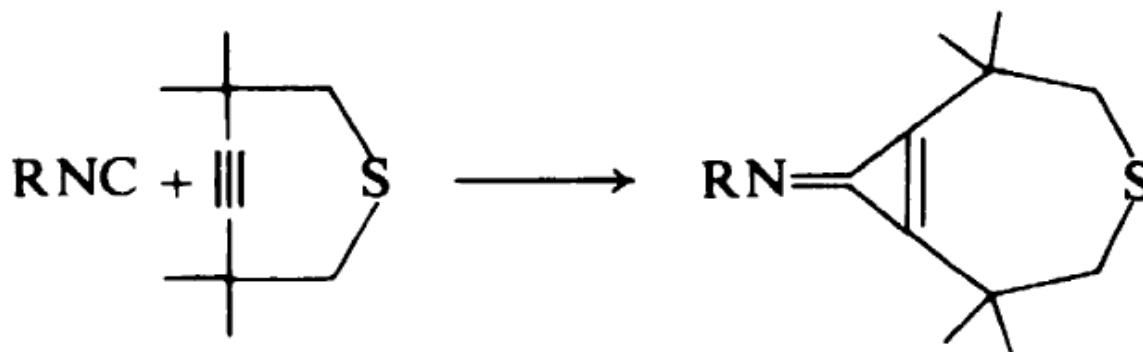





Aminometallation is also observed when isonitriles are treated with organolead and organotin amino compounds. This is a facile biphilic process.

The contribution of the carbene-like structure to isonitrile molecules renders them electrophilic as evidenced by condensation with active methylene compounds and phenols.

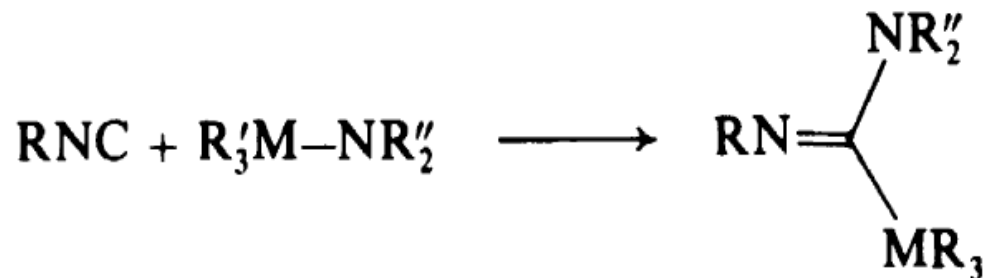

# ORGANIC CHEMISTRY OF GROUP IV ELEMENTS

A neutral silicon center is invariably a harder acceptor than the carbon counterpart. However, it is interesting to note that the direction of attack on Si of optically active 2-( $\alpha$ -naphthyl)-2-phenyloxasilacyclopentane by organometallic reagents is dictated by the hardness of the nucleophile. Harder bases interact with the vacant  $d_{xy}$  orbital of Si, whereas softer bases attack axially on the  $d_{z^2}$  of silicon. Hard bases attack silacyclobutanes at the heteroatom exclusively, whereas soft nucleophiles such as the Wittig reagents cause rupture of these molecules at a C-C bond.

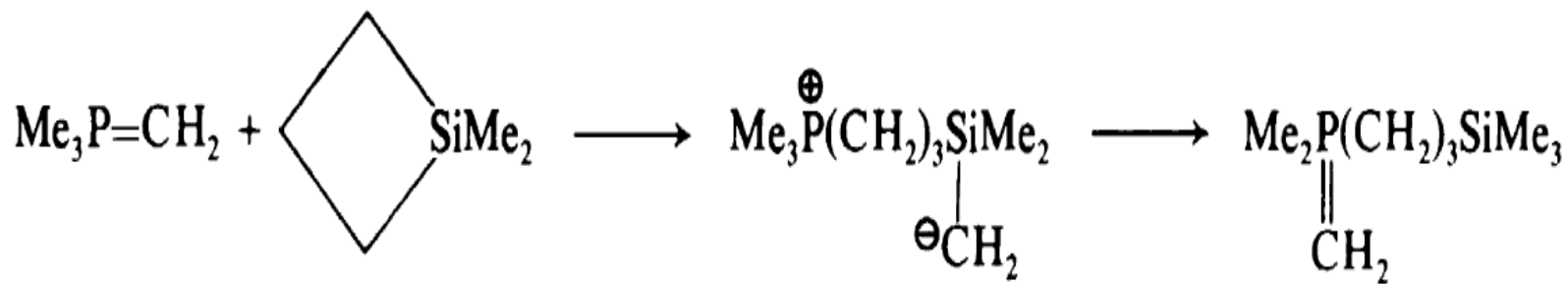

The unusual fragmentation of a disilane promoted by ethoxide ion as illustrated in the following reaction must be caused in part by the high affinity of Si for hard bases.

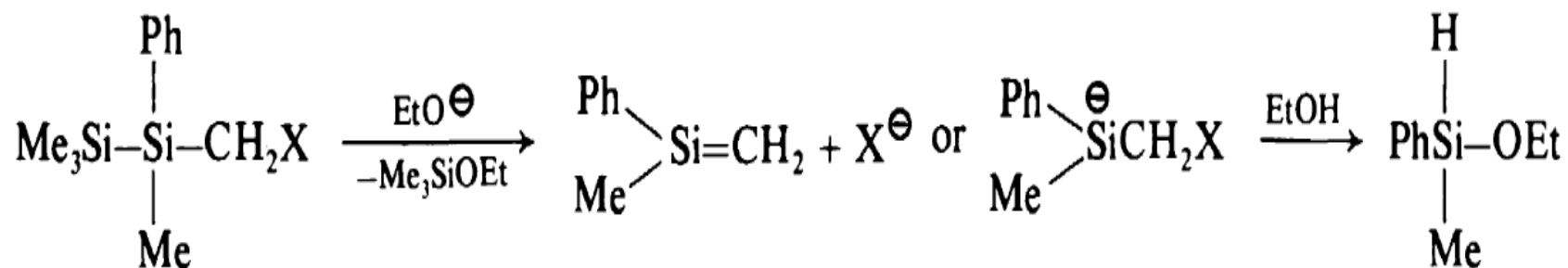

Another unexpected reaction pattern emerges from the acetolysis of dimethylsilacyclohexan-4-ol tosylate. The dominating factor is the hardness of the Si atom.

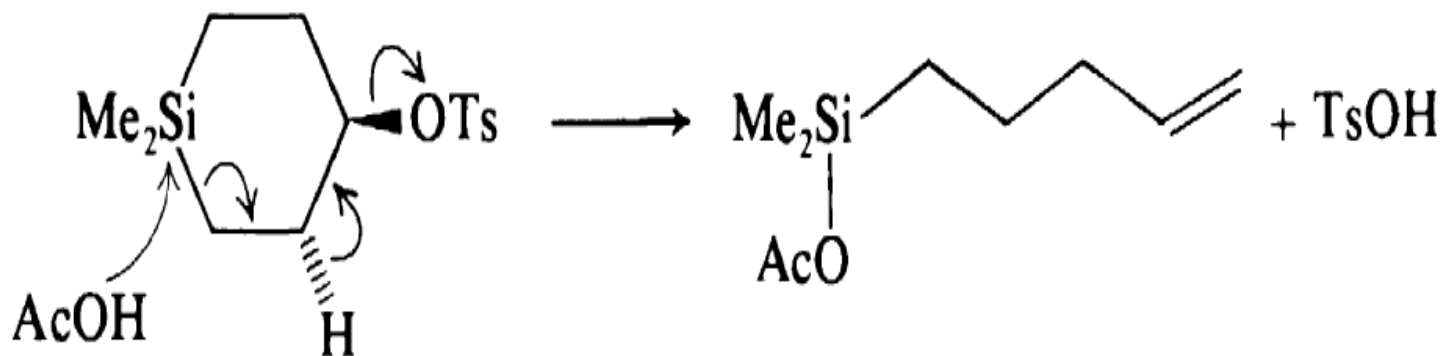

The thermal silicon-Pummerer rearrangement leads to a more compatible partnership among the various hard and soft moieties of the molecules.

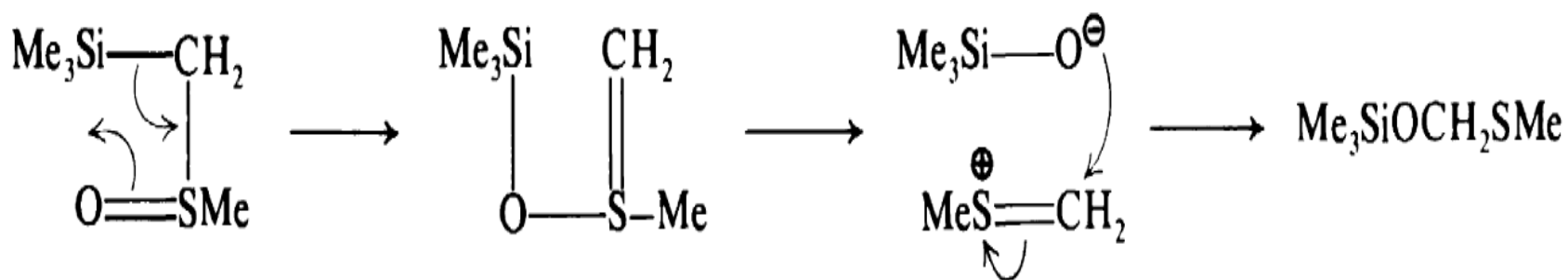

It has been postulated that intermediates containing Si-Tl bond are formed during the oxidation of aryldimethylsilanes with thallium triacetate. The silicon acts as a nucleophile toward Tl(III). However, the following mechanism consisting of a HSAB-matched transition state appears to be a better description.

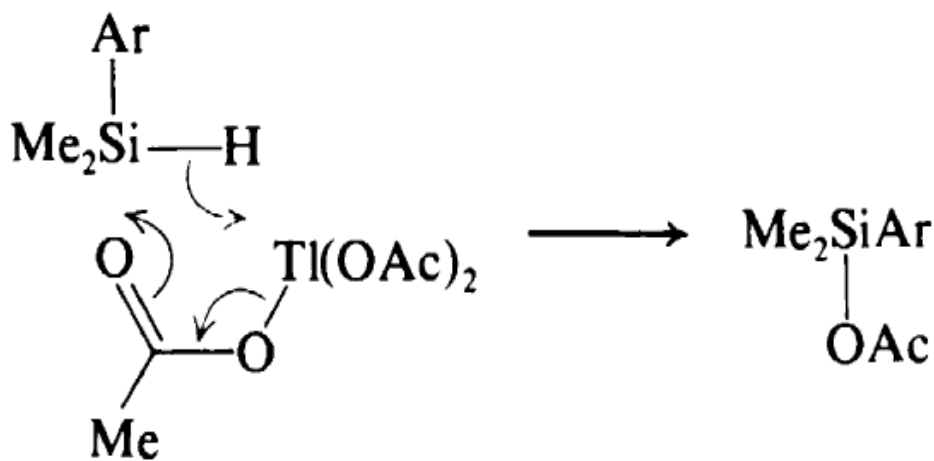

The observations that nucleophilic attack on acyloxysilanes by organometallics occurs at carbonyl and that the hard bases (ROH, ROR, RNH<sub>2</sub>) bind preferentially to silicon are by no means at variance with the HSAB theory, as silicon is harder than carbonyl carbon.

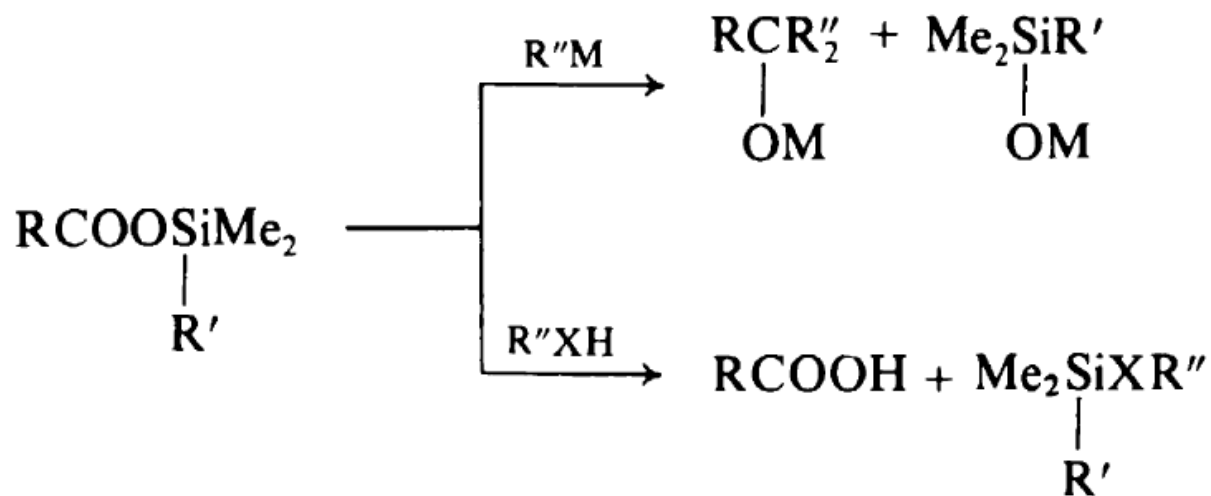



The quenching of dihydropyran anion with trimethylsilyl chloride yields only 2-trimethylsilyl- $\Delta^3$ -dihydropyran. The reaction takes place at the harder of the two basic centers (C-2, C-4). Carbon-2 is the harder because it is flanked on one side by an oxygen atom.

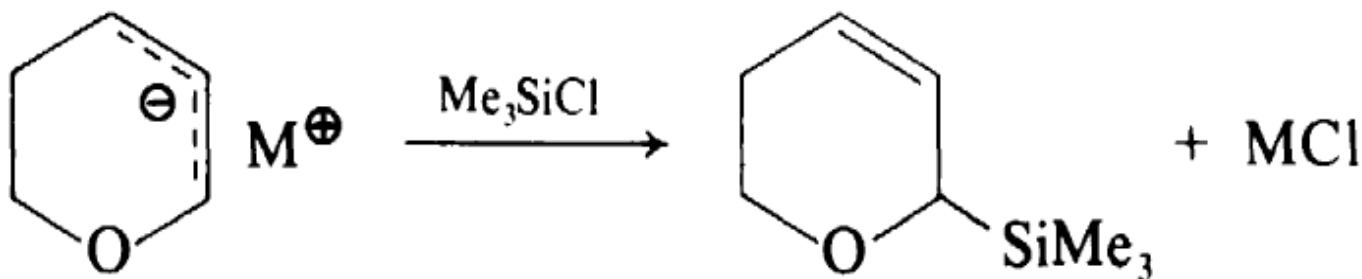

The pseudonitrosite of  $\omega$ -styryltrimethylsilane is decomposed by alcoholic hydroxide to furnish  $\beta$ -nitrostyrene. Silicophilic attack is preferred to abstraction of the very active hydrogen alpha to the nitro group.

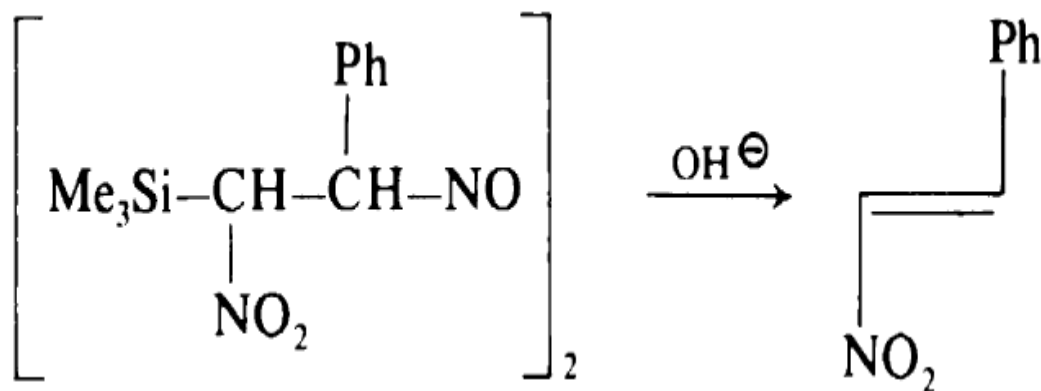

**$\alpha$ -Substituted benzyltriphenylsilanes rearrange on heating to products in which the harder groups are silicon-bound, apparently due to symbiosis.**

**The base-catalyzed and thermal rearrangements of  $\alpha$ -silylacetic acids and the conversion of  $\beta$ -ketosilanes to siloxyalkenes operate on the same principle.**

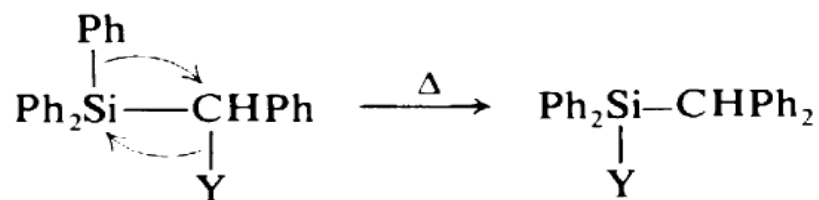

Y = F, Cl, OAc, OTs

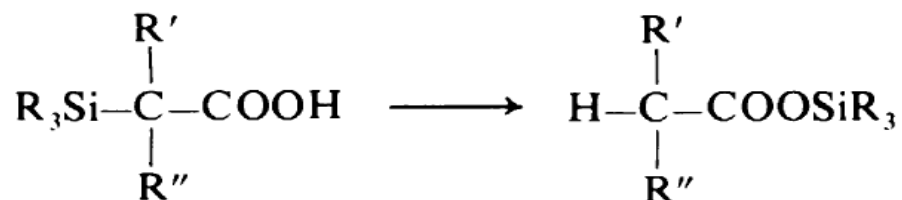

Although the dyotropic rearrangement of  $\alpha$ -siloxyalkylsilanes proceeds readily at moderate temperatures, decomposition is the major course for the sulfur analogs

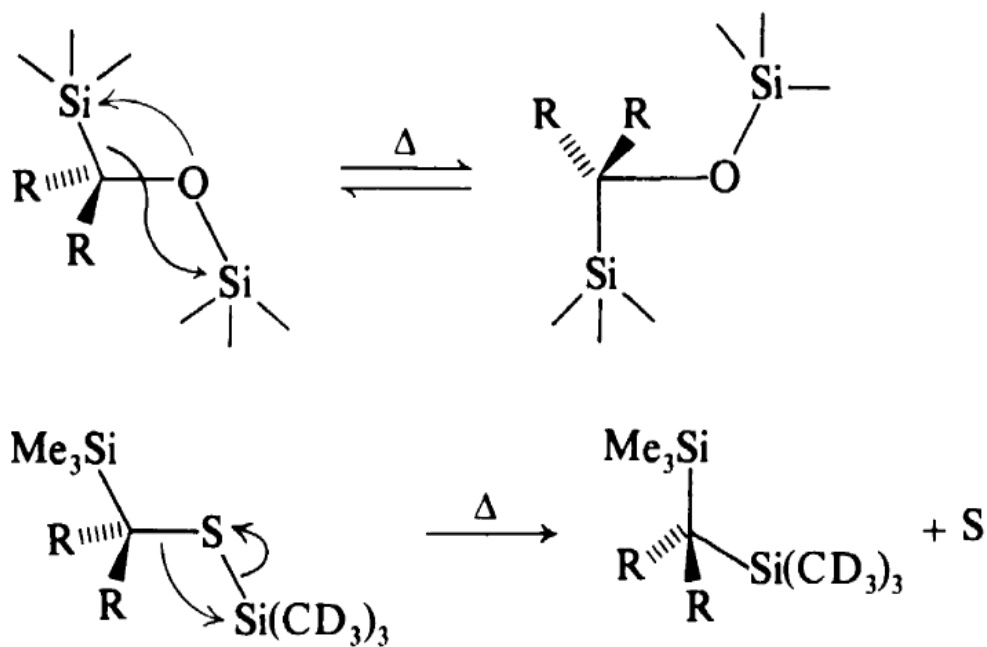

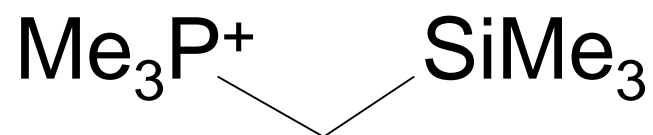

**silicon is a harder acceptor  
than tetrahedral phosphorus.**

Trimethylsilylmethylenephosphoranes have two different electrophilic sites (P, Si). Reaction of these species with methanol generates methoxytrimethylsilane and methylenephosphoranes. Apparently silicon is a harder acceptor than tetrahedral phosphorus.

Desilylation of organosilanes is most efficiently achieved by hard bases such as fluoride ion and oxy bases.

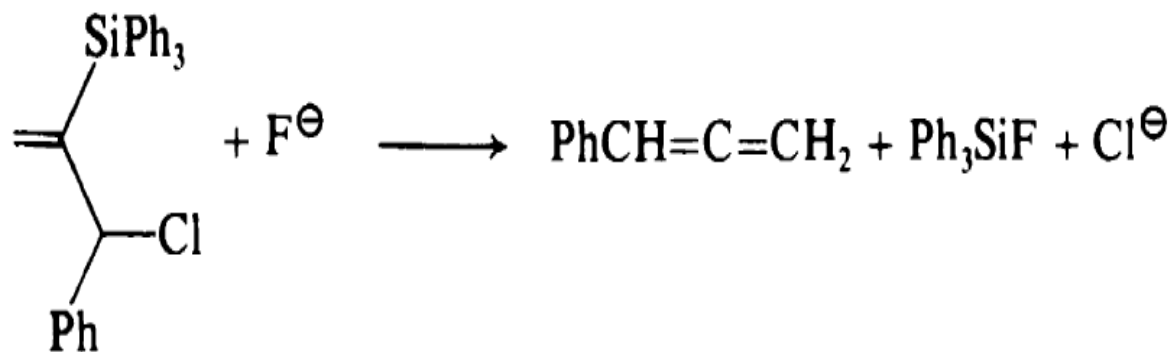

**The greater affinity of silicon for hard bases allows the preparation of iodoethynyl (trimethyl)silane by the following exchange reaction.**

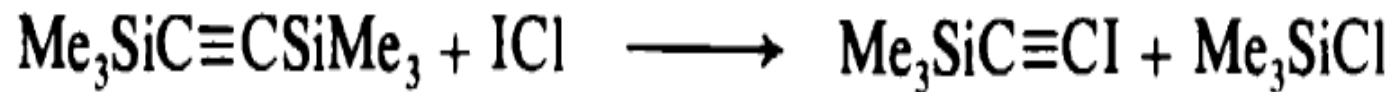

**Silylphosphines add onto the C=N group of aldimines to provide phosphinylated silylamines. Better matching for both the hard Si and the soft P atoms results.**

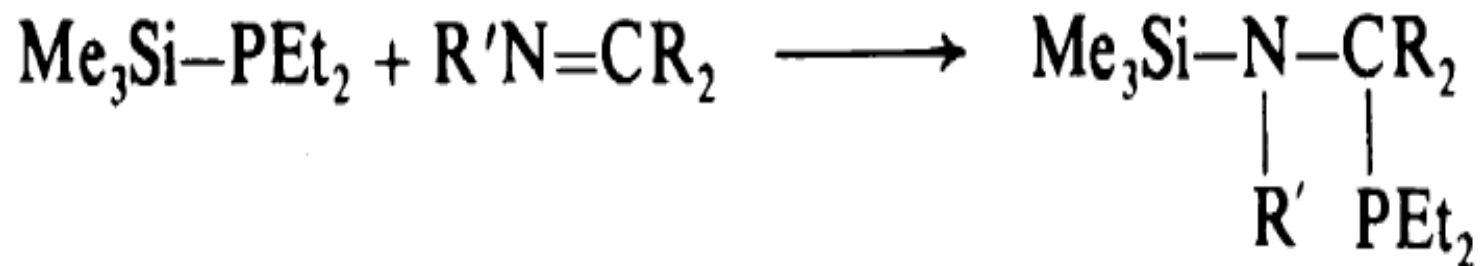



The same principle underlies the following facile transformation

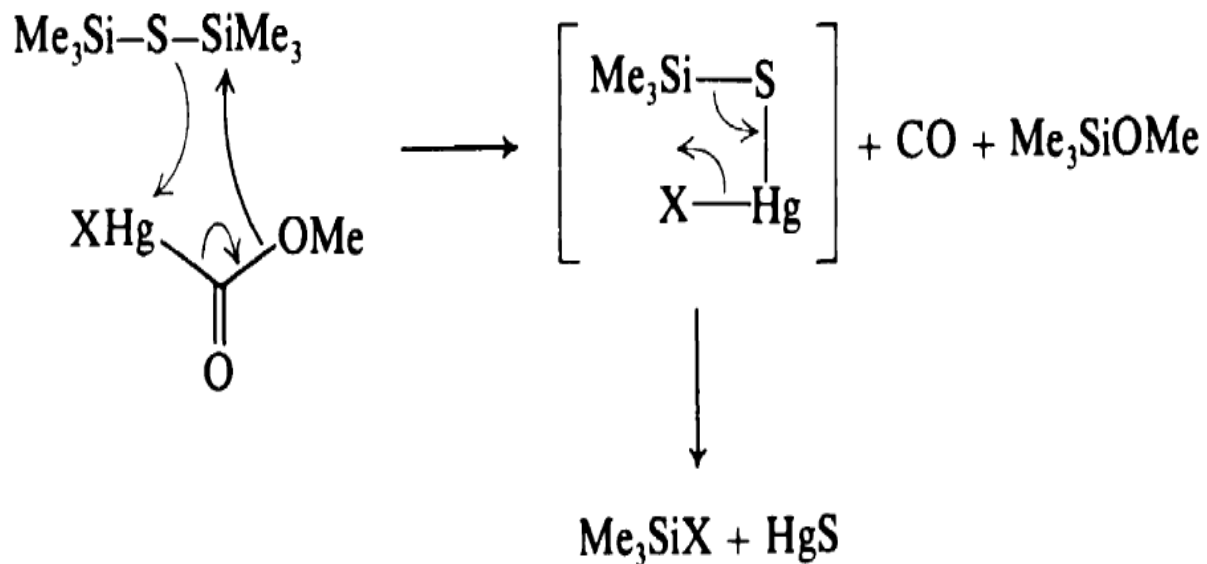

A method for hydrolysis of esters under neutral conditions has been developed based on HSAB considerations.

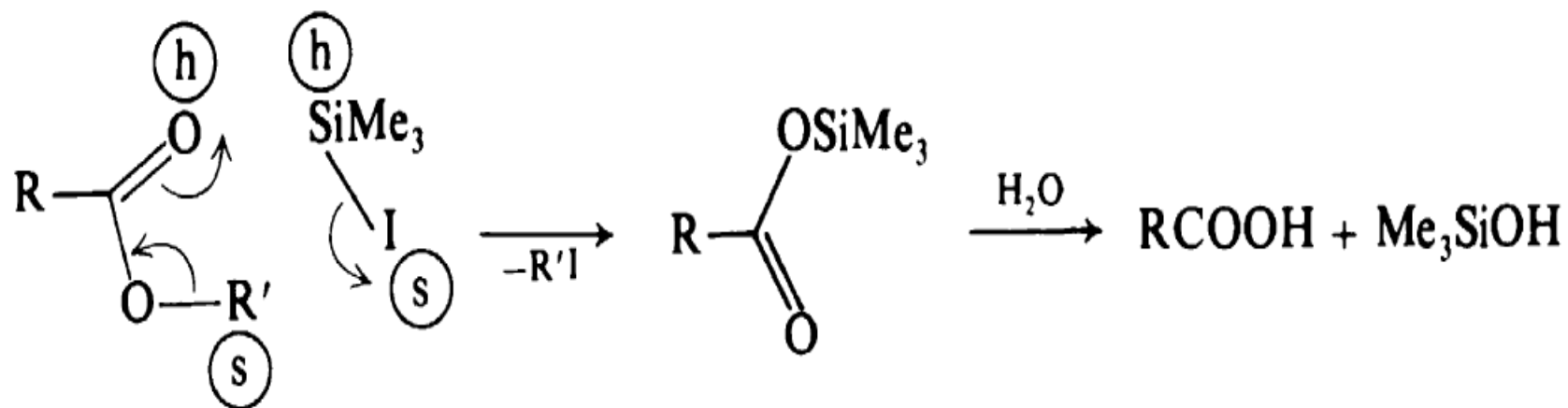

A combination of phenyltrimethylsilane and iodine is even more effective—presumably a favorable termolecular transition state is attained during the reaction.

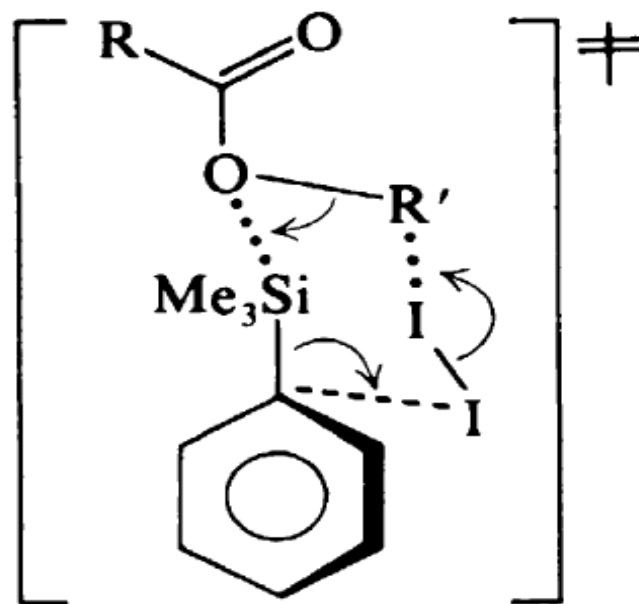

Such a mechanism receives support from the observation that aryl alkyl ethers are readily cleaved by the  $\text{PhSiMe}_3\text{-I}_2$  reagent but only inefficiently by iodotrimethylsilane.

Sulfenamides are formed when sulfenate esters are treated with amines or their trimethylsilyl derivatives.

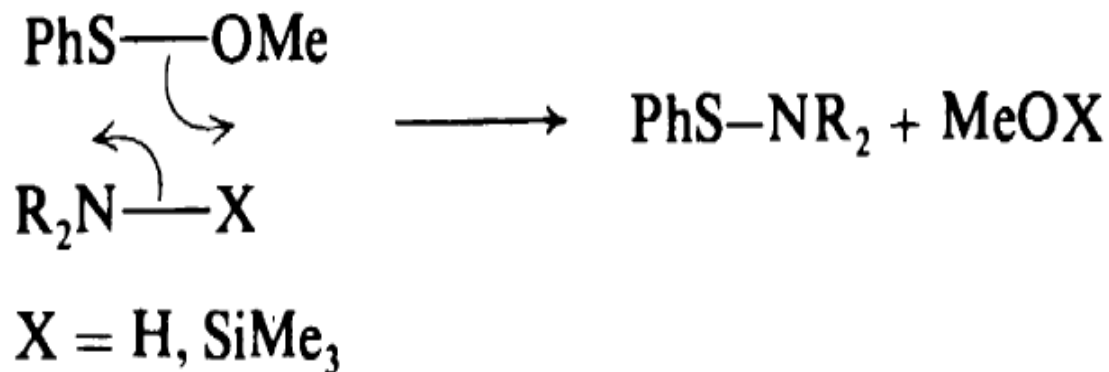

**1,4-Addition to 1,1-bis(trihalomethyl)-2,2-dicyanoethylenes by various metalloid compounds has been reported. Again the HSAB principle is followed.**

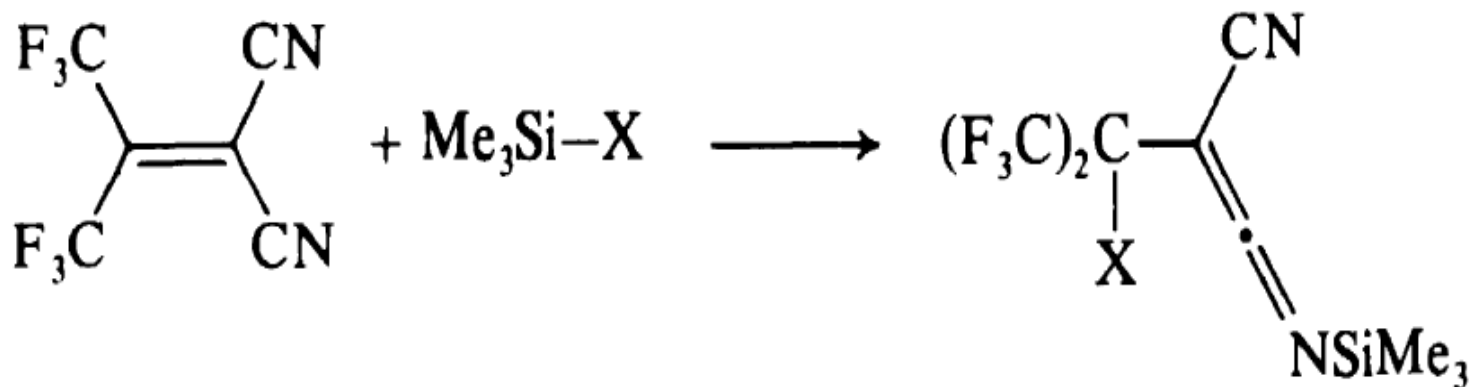

$\text{X} = \text{H}, \text{PhNH}, \text{MeS}$

The trimethylsilyl group of enol silyl ethers can participate in ene reactions with singlet oxygen

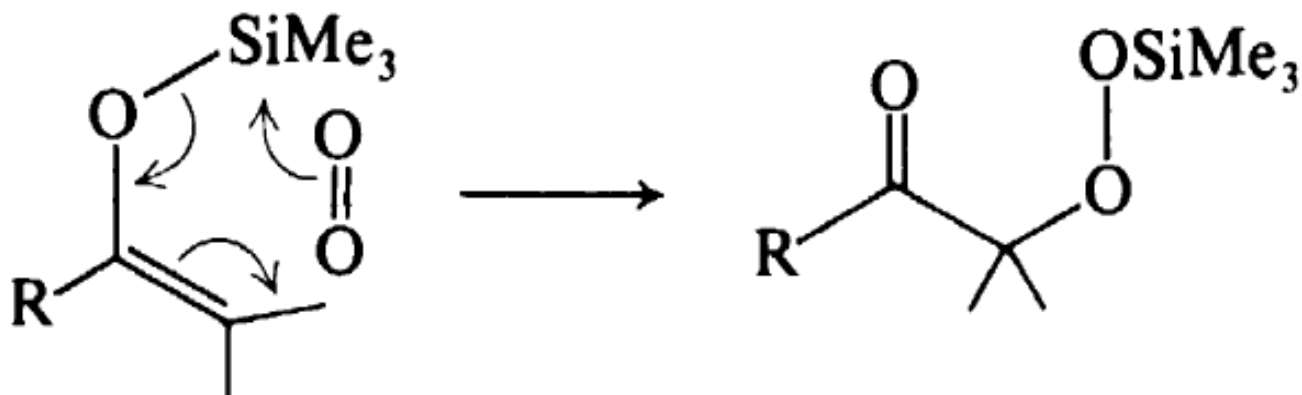

Owing to the hardness of Si(IV) and Sn(IV) nuclei, triorganosilyl and triorganostannyl groups can act as electrofugal moieties during heterolysis initiated by an electron-deficient  $\beta$  atom.

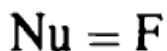
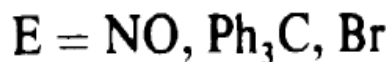
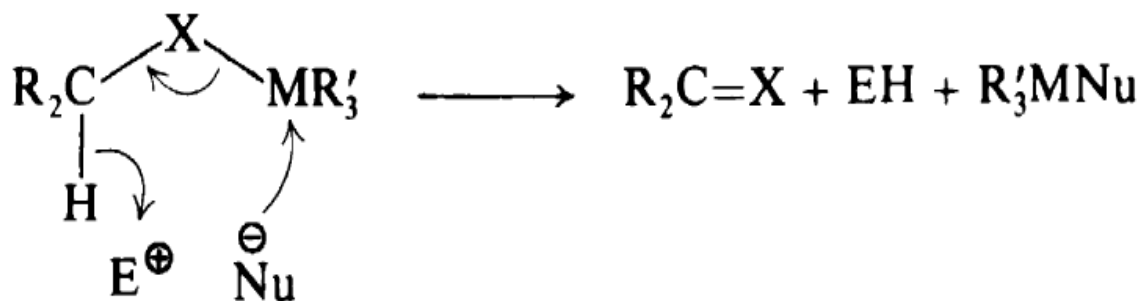

## High reactivity toward electrophiles and fragmentability of allylsilanes are due to:

Is a softer donor compared to a nonconjugated atom

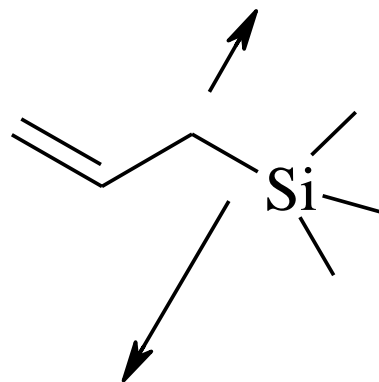

Very weak



**4-Tributylstannylbut-1-ene undergoes a remarkable cyclodestannylation on exposure to electrophiles. Because tin is harder than carbon, the observed fragmentation transfers the net charge to the tin and is energetically profitable.**

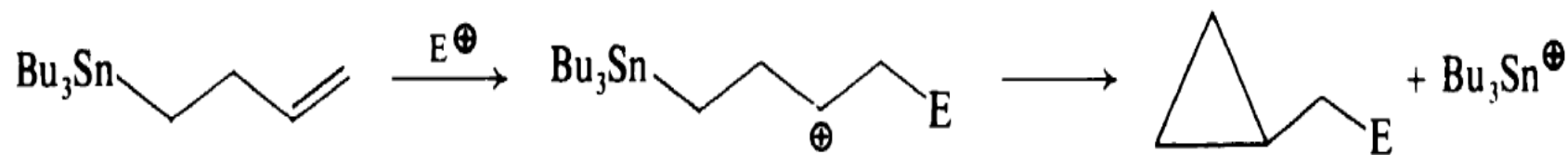

$\text{E} = \text{I}, \text{Br}, \text{Cl}, \text{HgCl}, \text{etc.}$

In the synthesis of orthocarbonates by the reaction of carbon disulfide with dialkoxystannanes, each successive stage is aided by symbiosis.

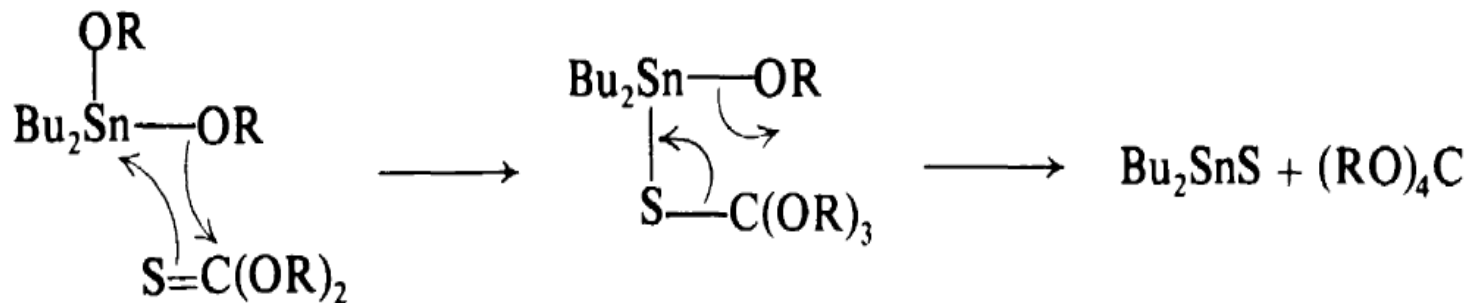
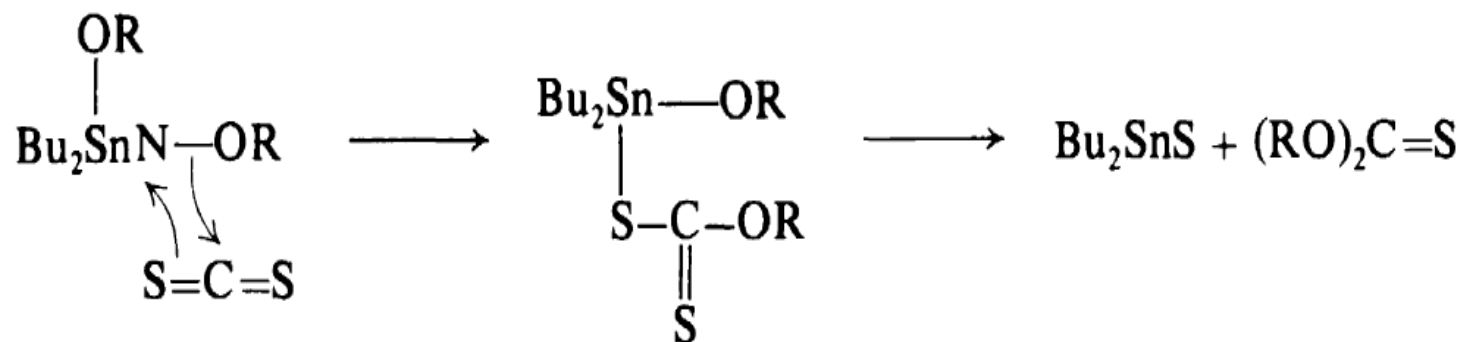

# REACTIONS OF ORGANOHALIDES, GRIGNARD AND RELATED REAGENTS

**The C—X bond (where X = Br, I) can be considered as a soft acid-base pair. The halogen may act as either an acid or a base, depending on its environment and on the nature of the reaction involving the breakage of C-X linkage.**

**Ordinary alkyl halides are thermally stable. On the other hand, cyclopropyl halides may undergo ionization concomitant with fission of a ring C-C bond.**

**The ease of C-X bond cleavage parallels the softness of X. For example, the dibromocarbene adduct of norbornene rearranges during its preparation and the corresponding dichlorocarbene adduct can be isolated.**

**Rearrangement of the latter compound can be brought about by mild heating, whereas a higher temperature is required for breaking the C-F bond in an analogous system. Intrinsic bond strength is the determining factor; however, it is believed that softness also contributes to the observed variation.**

**In the formation of exocyclic bonds cyclopropane utilizes harder orbitals (more s character). It follows that a soft substituent destabilizes the molecule, thus the C-Br bond of bromocyclopropane should be weaker than that of 2-bromopropane. Conversely, the C-F bond of fluorocyclopropane is expected to be as strong, if not stronger, than that of 2-fluoropropane.**



**1-Chloro-1-(cyclopropylethynyl)cyclopropane undergoes halide-metal exchange with  $n$ -BuLi. Interestingly, an  $S_N2$  displacement of the chlorine by a phenyl group of the harder PhLi reagent is noted**

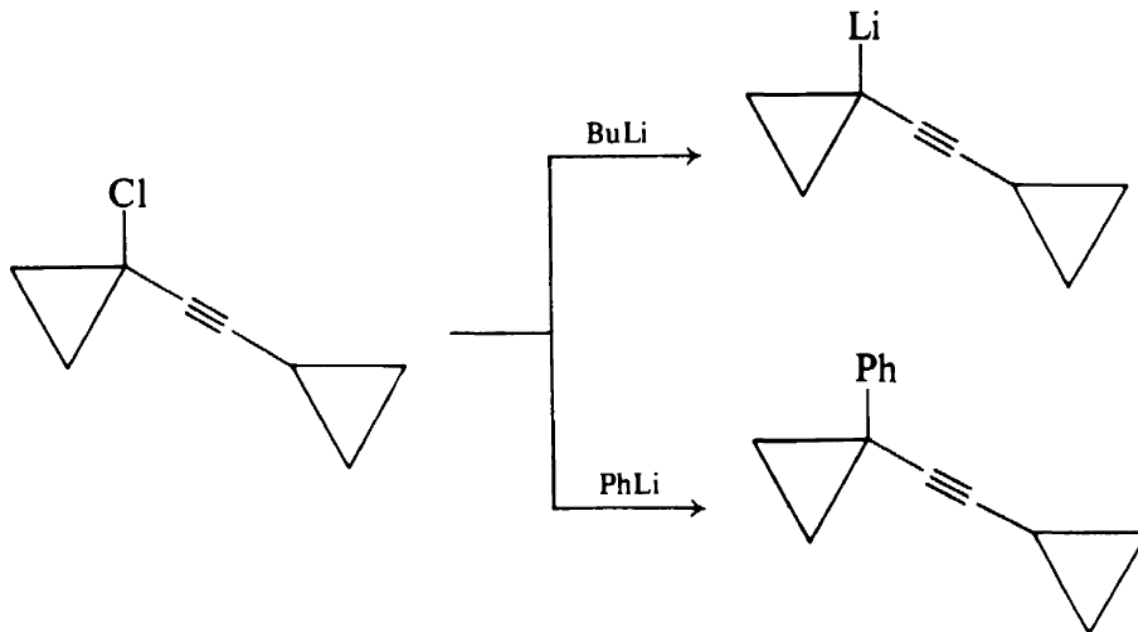

**Masamune *et al.* have studied the stereochemical consequences of reductive removal of halo (Cl,Br) and mesyloxy groups with a Cu(I) hydride reagent.**

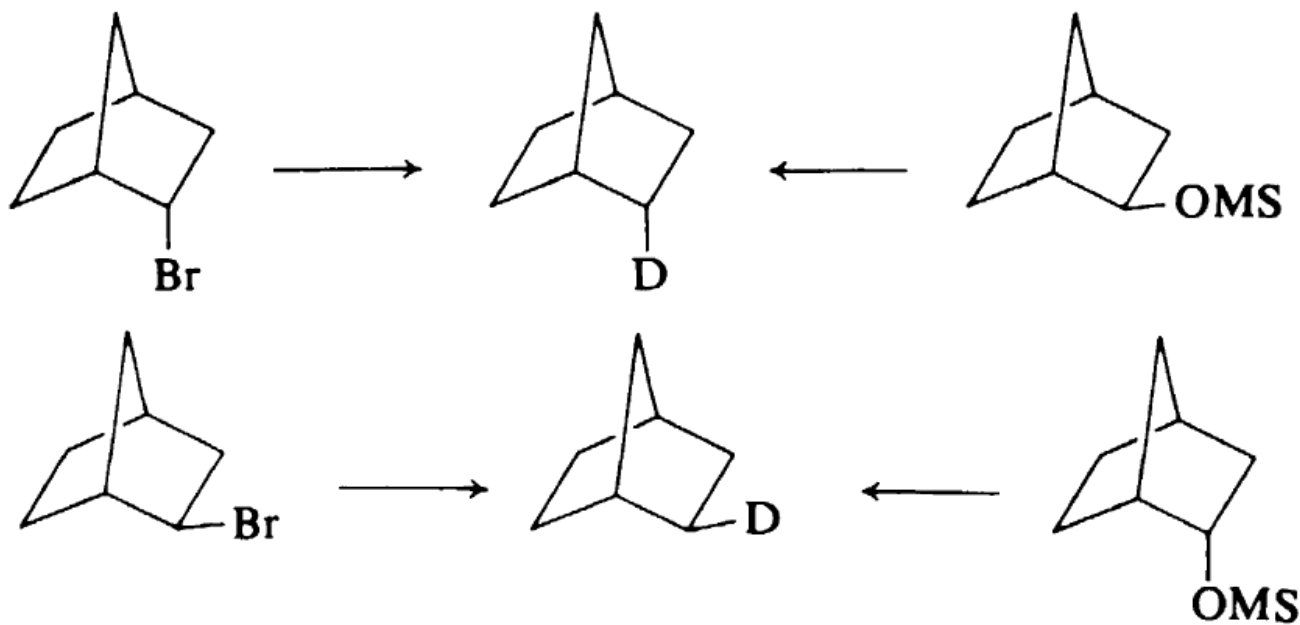



Similar duality exists during the coupling studies of benzyl derivatives with diorganocuprates. It is now well known that diorganocuprates are soft nucleophiles which displace organohalides (bromides, iodides) with ease.

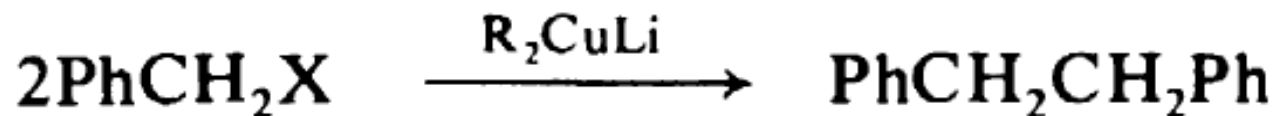
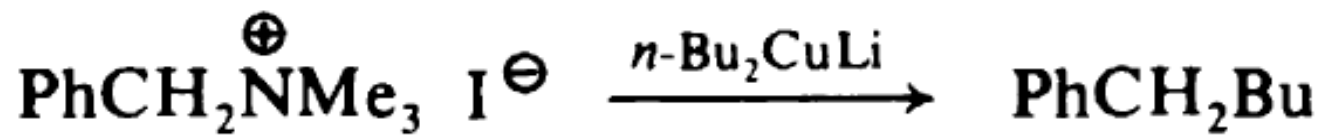

X = halide

The nucleophilic displacement of 1-aryl-2-haloacetylenes with various bases correlates quite well with the HS AB principle with respect to the attacking sites.

Both bromine atoms at C-4 of 2,4,4,6-tetrabromocyclohexa-2,5-dienone are extracted by di(phenylethynyl)mercury, presumably via the mechanism shown below.

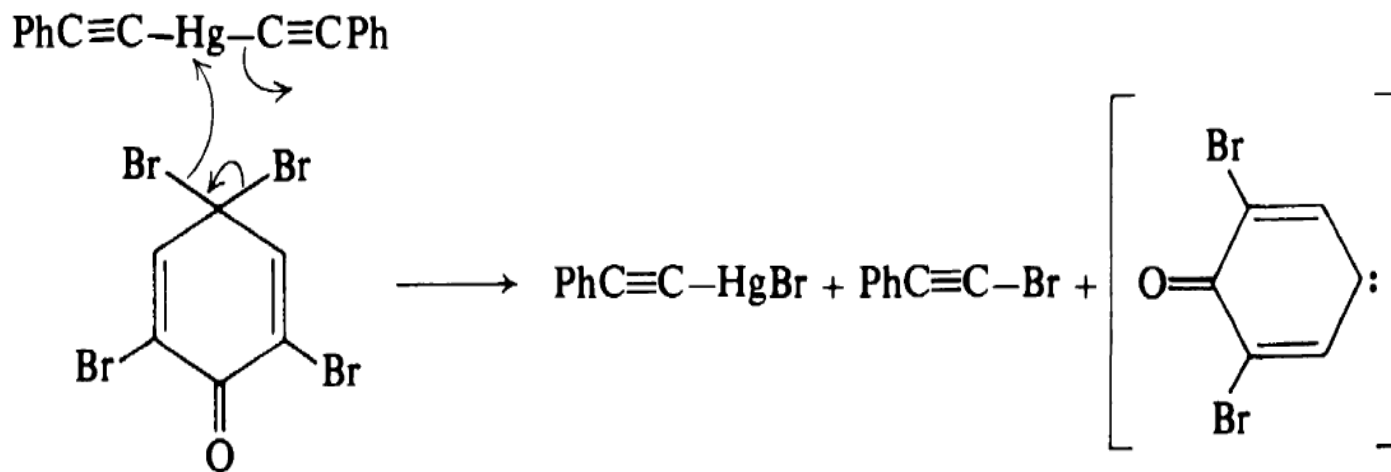

The dienone is a good donor of  $\text{Br}_2$  and it may be used for promoting the dimerization of thiols. The efficiency of this process is quite remarkable in comparison with the bromination of harder substrates by the same reagent. Cyanogen bromide also effects disulfide formation.

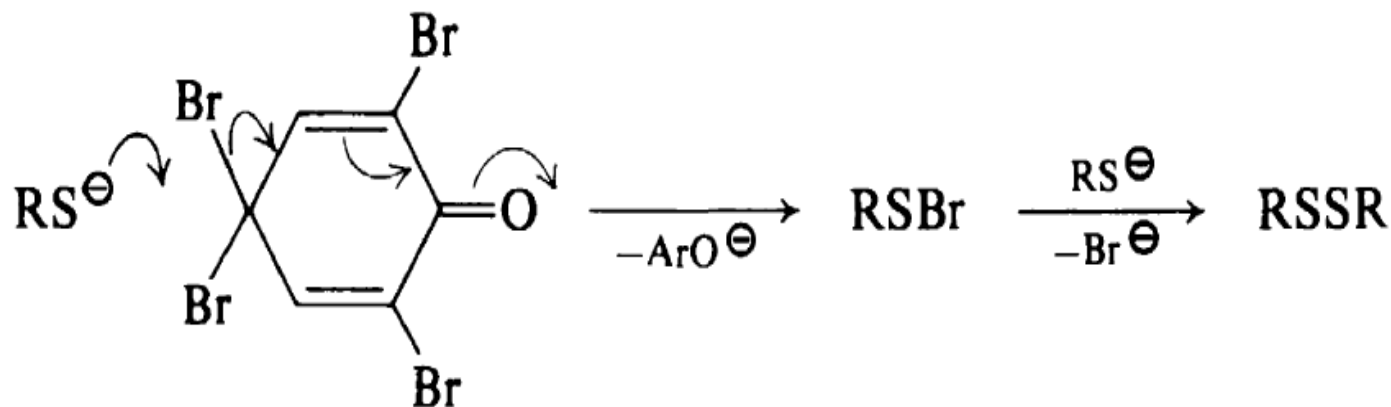

**Grignard discovered that alkylmagnesium halides react with cyanogen chloride and cyanogen iodide in different ways.**

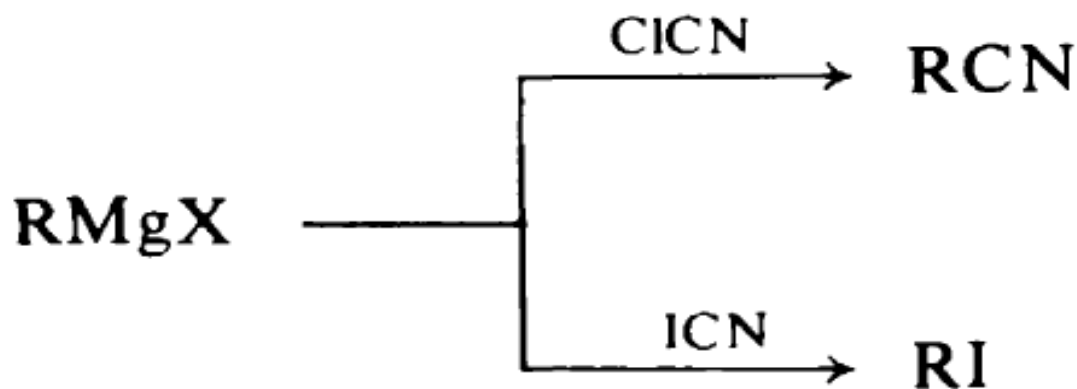

More recently, cleavage of the aryl C-Sn bond by cyanogen halides has been shown to give either aryl bromides or cyanides. The dichotomy may be readily explained by the difference in the softness of the acceptors  $I^+ > Br^+ > CN^+ > Cl^+$ .

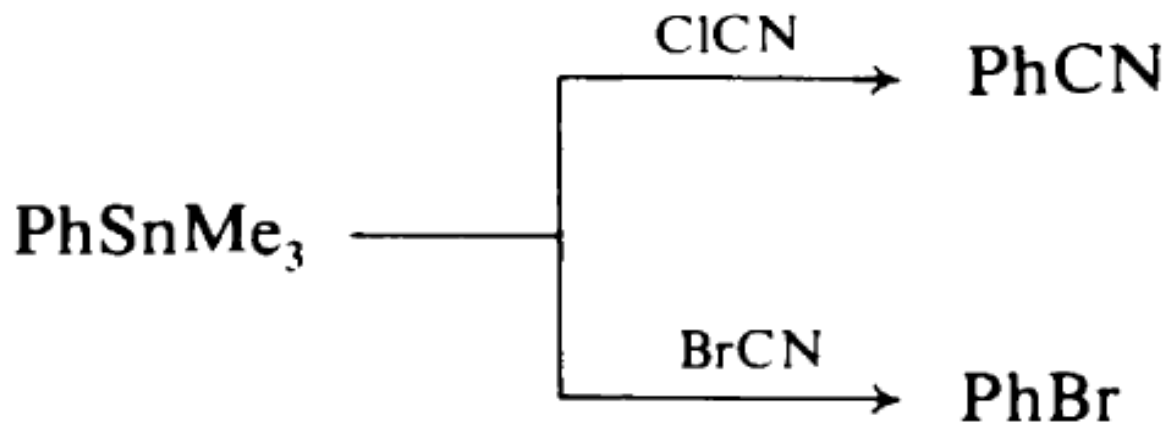

**In a synthesis of sulfonylnitriles from sodium sulfinates, the soft sulfur nucleophilic center binds to the cyano group of cyanogen chloride. Benzoyl fluoride is more reactive than benzoyl chloride toward phenylmagnesium bromide. However, the reactivity of acyl halides with di-*p*-tolylmercury decreases according to the sequence:**



# EXCEPTIONS

**These exceptions may simply mirror our presently imperfect understanding of certain subtle bonding aspects or other undetermined factors.**

**Hudson has stressed that many pitfalls lie in the area of ambident reactivity which could lead to interpretive labyrinths. A knowledge of the nature of the transition state is imperative in avoiding these pitfalls.**

**The apparent contradiction to symbiosis during acetolysis of hex-5-enyl derivatives is inferred from the observation that more double-bond participation products arise from the arenesulfonates than the softer halides.**

**Pearson argues that the solvolysis may be more complex than a simple  $S_N2$  type displacement and as such there is no reason for symbiosis to be the dominant factor.**



The Claisen condensation of esters normally gives  $\beta$ -keto esters. Acylation of tricarbalkoxymethide ions also leads to reaction at the carbon atom. The aberration from the HSAB principle could be due to intervention of preequilibrium and rearrangement, respectively.

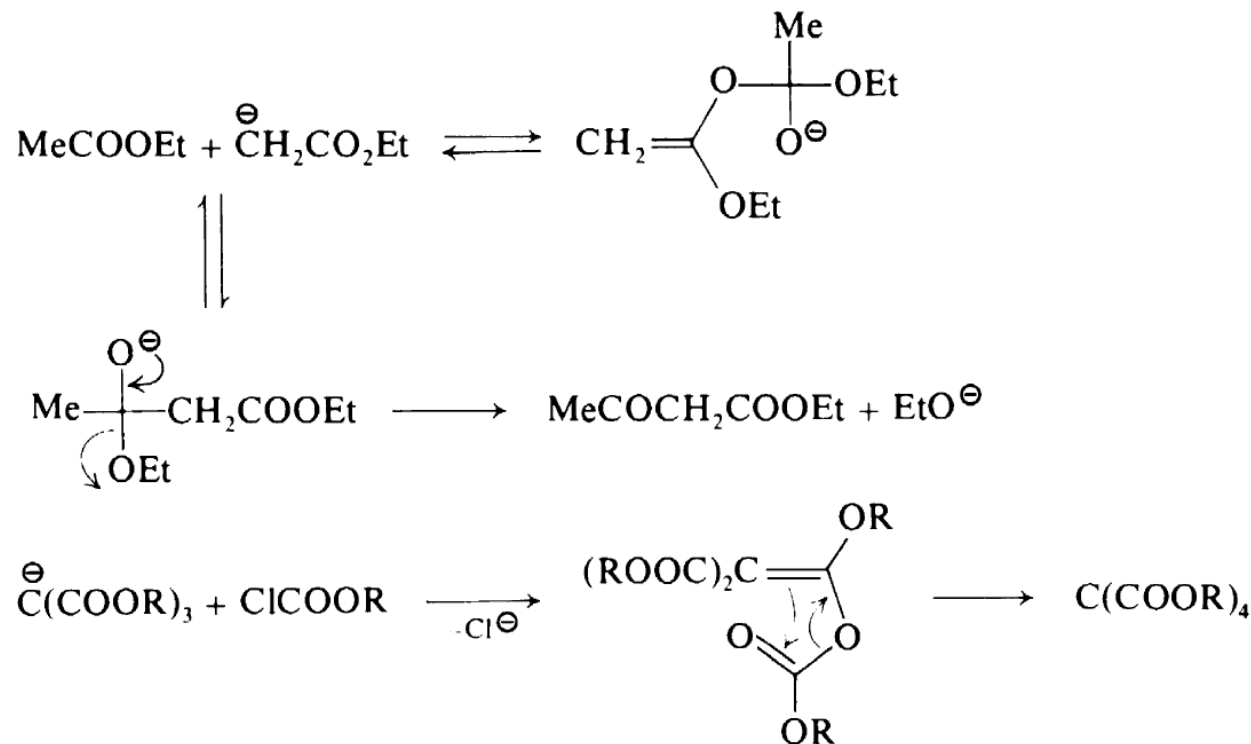

The inter- vs. intramolecular alkylation of 2-bromoethyl ester anions cannot be explained on simple terms.

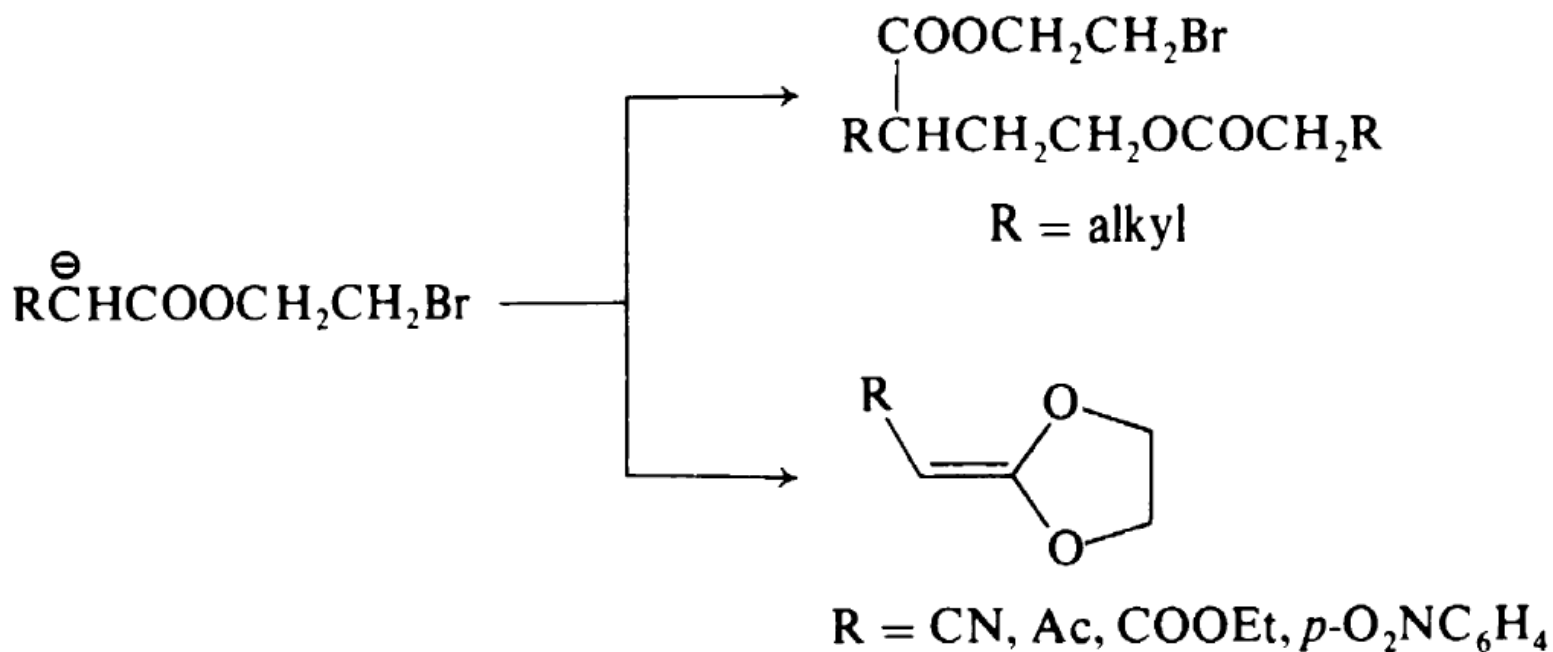

**Thallio(I)carbazole attacks vinyl acetate to afford TV-acetylcabazole.**

**The potassium salt undergoes  $\alpha$ -acetoxyethylation on the nitrogen atom when it is treated with the same reagent.**

**It may be envisaged that during Nacetylation of thallicarbazole there exists a soft-soft interaction between the double bond of vinyl acetate and the thallium which brings the nitrogen atom and the carbonyl group into juxtaposition and releases electrons for the formation of the N-C bond.**

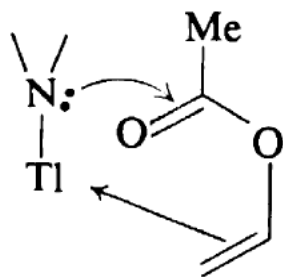
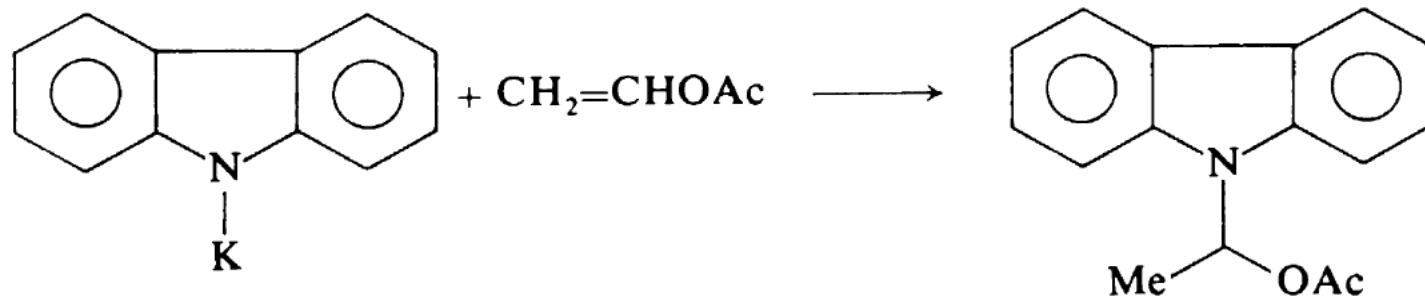
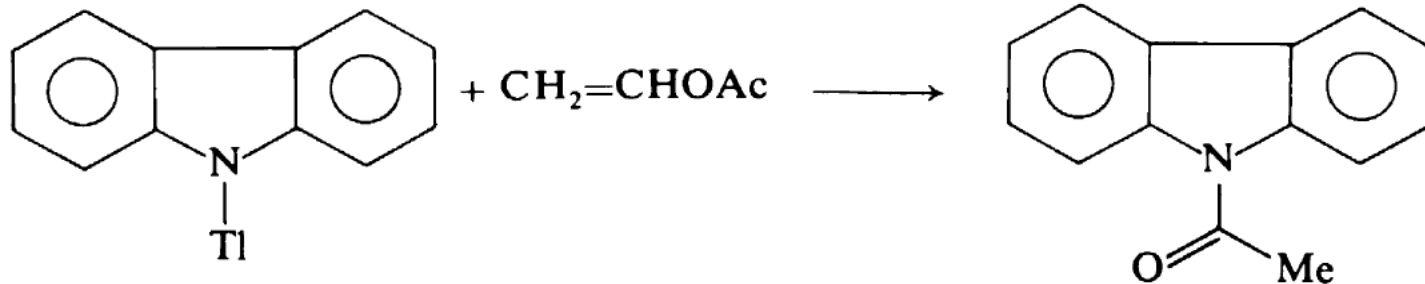

The migratory aptitudes toward carbenes,  $H > Ph > Me$  and  $SH > H > OR, NR_2$ , parallel the relative softness of the groups. It is important to note that  $\pi$  participation is involved during phenyl shift. The mechanism by which a neighboring hydrogen migrates to a carbenic center has been investigated by *ab initio* molecular orbital calculations.

**Isonitriles are generally considered hybrids having the canonical structures.**

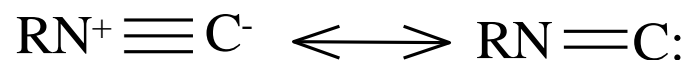

**They exhibit soft characteristics in reactions with Michael acceptors, positive halogen compounds and elemental sulfur.**

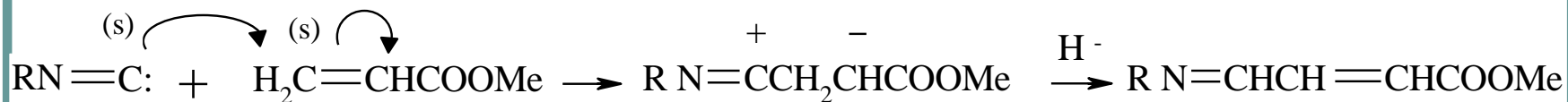

## High reactivity toward electrophiles and fragmentability of allylsilanes are due to:

Is a softer donor compared to a nonconjugated atom

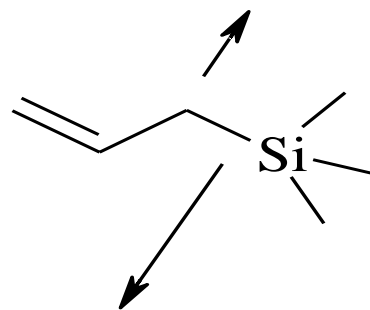

Very weak

Is softened to a large extent by the organic ligands

